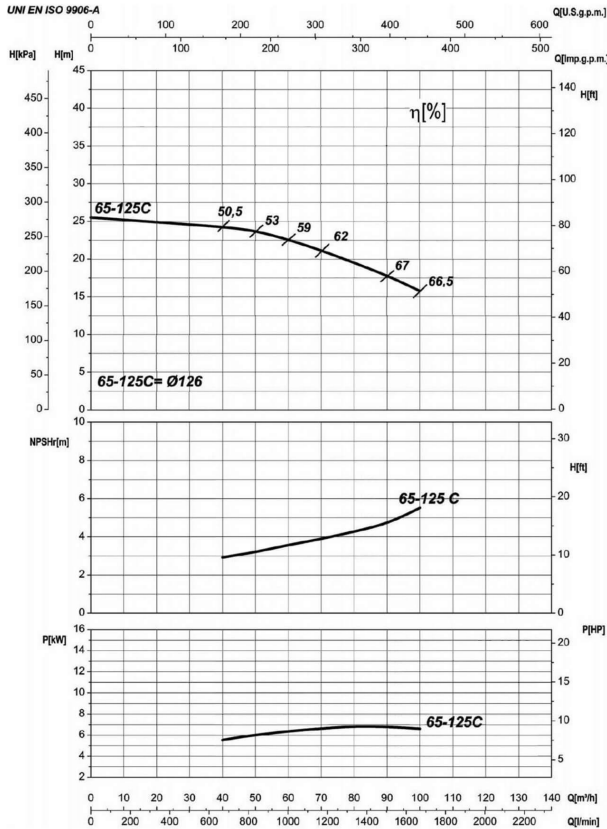

Receiver

From

 Company name
 Respons. Department
 Person in charge
 Phone number
 Fax no
 E-mail address

Operating data specification

Nominal flow	US g.p.m. 0
Nominal head	ft 0
Static head	ft 0
NPSH - v value of plant	ft 0
Inlet pressure	psi 1.42
Fluid	Water, pure
Operating temperature t A	°F 68
Density at t A	lb/ft³ 62.32
Kin. viscosity at t A	ft²/s 1.082E-5

Pump

Pump name	6IR65-125C	
Size	80/65/125	
Design		
Speed rpm	3600	No of stages 1
Impeller type		
Flow	Nominal	US g.p.m.
	Max-	US g.p.m. 440
	Min-	US g.p.m. 176
Head	Nominal	ft
	Max-	ft 80
	Min-	ft 52.7
Head H(Q=0)	ft 84.2	
NPSH 3%	ft	
Max. working pressure	psi 36.4	
Shaft power	hp	
Efficiency	%	
Max absorbed power	hp 8.9261	

Materials Pump

Shaft	Stainless steel AISI 431 (1.4057)
Impeller	Cast iron EN-GJL-250
Pump body	Cast iron EN-GJL-250
Seal disc	Cast iron EN-GJL-250
Gasket	Natural fiber
Mechanical seal	BVEG (Grafito/Ossido Allumina/EPDM)

Dimensions in inch

a	3 ¹⁵ / ₁₆
b	2 ⁹ / ₁₆
DNA	3 ⁷ / ₈
DNM	2 ⁹ / ₁₆
f	16 ¹¹ / ₁₆
h1	6 ⁵ / ₁₆
h2	7 ¹ / ₁₆
m1	4 ¹⁵ / ₁₆
m2	3 ³ / ₄
n1	11
n2	8 ³ / ₈
s	9 ¹ / ₁₆
w	11 ⁷ / ₈

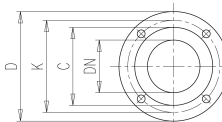
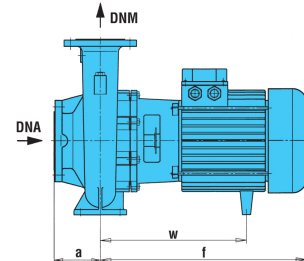
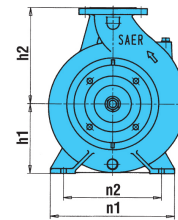

C	4 ⁹ / ₁₆	C	5 ⁷ / ₁₆
D	7 ⁵ / ₁₆	D	7 ⁷ / ₈
DN	2 ⁹ / ₁₆	DN	3 ⁷ / ₈
K	5 ¹¹ / ₁₆	K	6 ⁵ / ₁₆
n°	3 ¹ / ₁₆	n°	3 ¹ / ₁₆
ø n	3 ¹ / ₄	ø n	3 ¹ / ₄

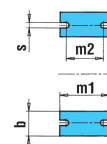

Motor	Frame size	112 M		
Manufacturer / Type	SAER	MEC112M-2P-7.5		
Rated power	hp	10.058	Efficiency 4/4	87 %
Electric current	A	12.4 A	Speed rpm	3600
Electric voltage	V	460V	3~	Hz 60
Starting mode	Unknown			
Degree of protection	IP 55	Insulation class	F	

Remarks:

Project	Project ID	Created by	Created on	Last update
			2022-08-01	

Receiver

From

 Company name
 Respons. Department
 Person in charge
 Phone number
 Fax no
 E-mail address

Operating area	Flow	Head	Impeller type
Operating data specification	0 US g.p.m.	0 ft	Closed
Pump data	US g.p.m.		Sense of rotation
	ft		Clockwise from the drive end
	Speed		rpm
	Frequency		Hz
			3600 60 Hz

 Performance data based to: Water, pure [100%]; 68°F; 62.3lb/ft³; 1.08E-5ft²/s

UNI EN ISO 9906:2012 - Grade 3B

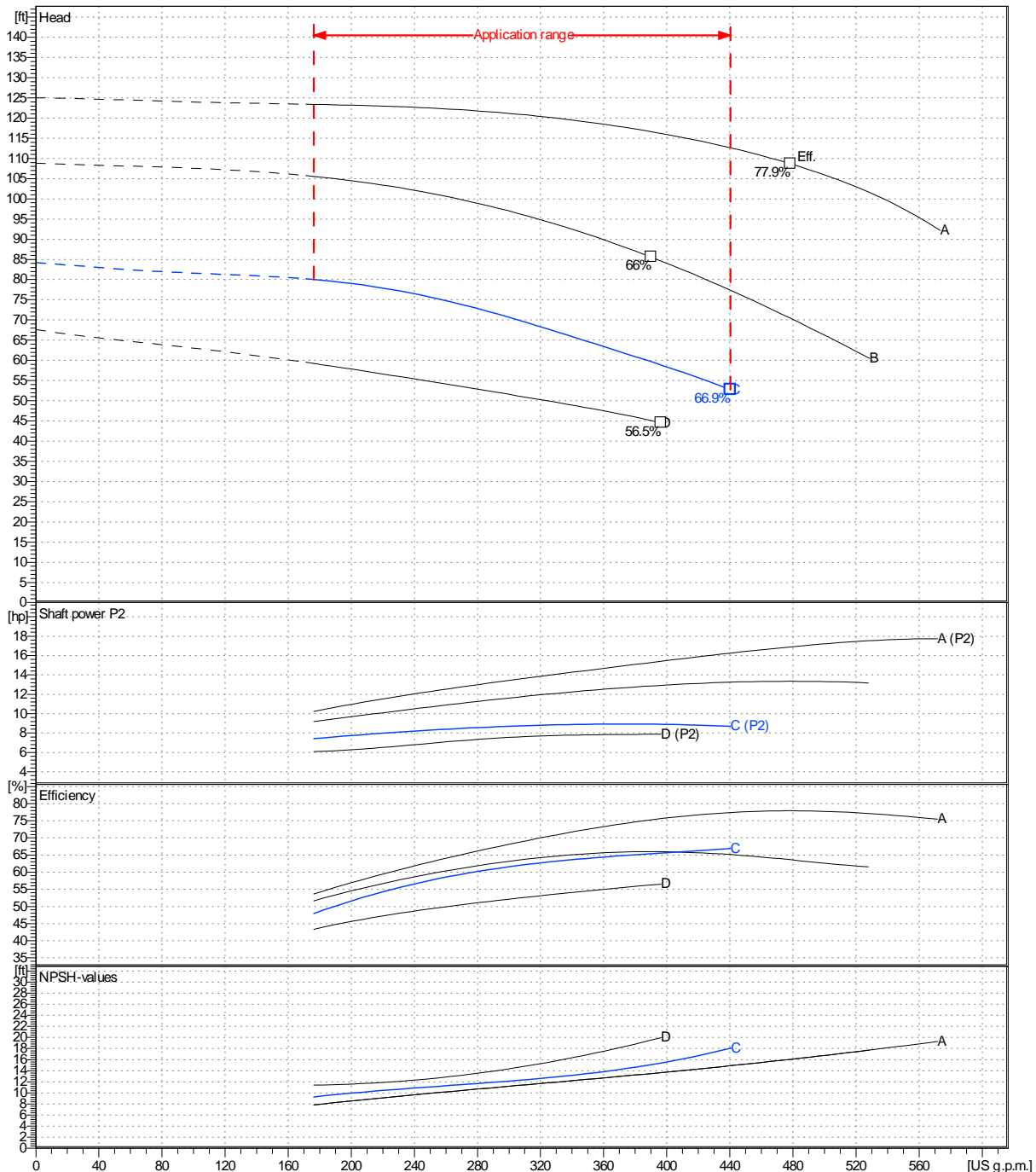

Project	Project ID	Created by	Created on	Last update
			2022-08-01	

Company name
Respons. Department
Person in charge
Phone number
Fax no
E-mail address

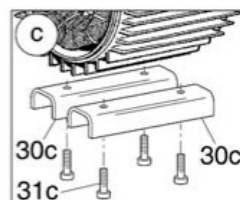
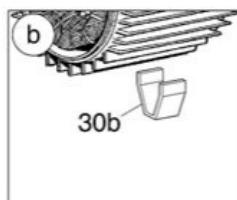
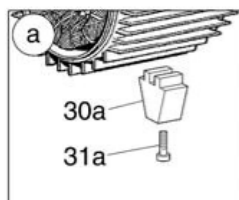
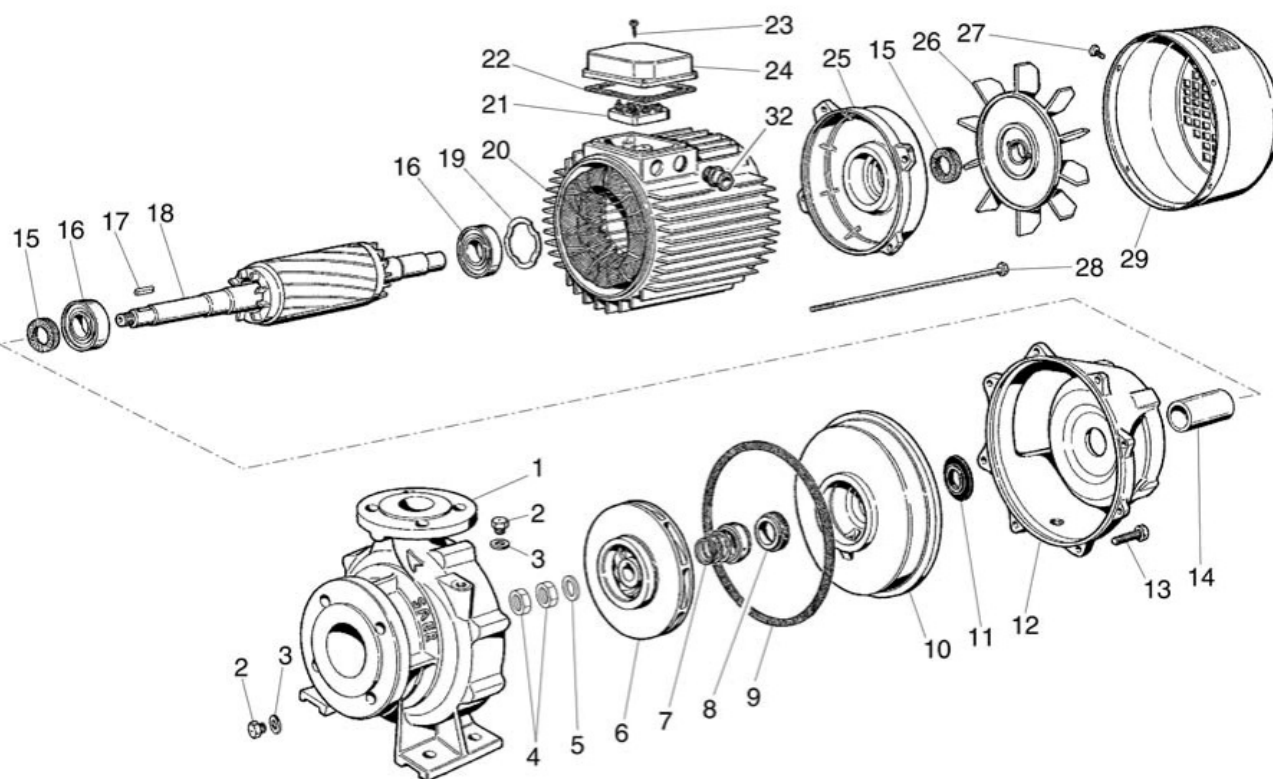

Project

Project ID

Created by

Created on
2022-08-01

Last update