



Technical Data

Multi-Stage Horizontal Pump - CBI 4-30

Revision no.

 Page:
1

Receiver

From

 Company name
 Respons. Department
 Person in charge
 Phone number
 Fax no
 E-mail address

--	--



Brand: Gol Pumps
Model: CBI 4-30
Material: Stainless Steel

Enclosure class	IP54
Insulation class	F
Liquid temp. range	32 °F ~ +194 °F
Max. ambient temp.	+104 °F
Max. operating pressure	142 PSI
Max. inlet pressure is limited by Max. operating pressure	
Mechanical seal	CQBE

The Max. operating pressure depends on the temp. of the pumped liquid

142 PSI	85 PSI
32 °F to +104 °F	+106 °F to +194 °F

Dimensions:

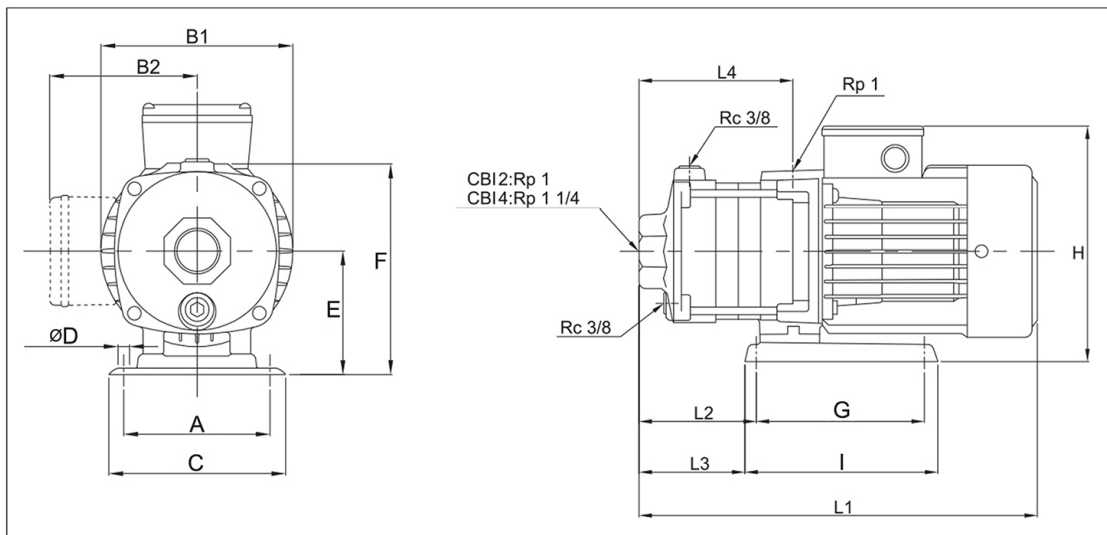

Inlet	Outlet
1 1/4"	1"

Pump Installation Size (inch)														Weight
A	B1	B2	C	ØD	E	F	G	H	I	L1	L2	L3	L4	lb
4.3	5.6	5	5.1	0.3	3.6	6.1	5.4	9	6.3	15.1	4.4	3.9	5.4	24.4

Project

Project ID

Created by

Created on

Last update



Performance Curves

Multi-Stage Horizontal Pump - CBI 4-30

Revision no. Page: 2

Receiver From

Company name
 Respons. Department
 Person in charge
 Phone number
 Fax no
 E-mail address

Model	Capacity			Head		Speed	Motor	Voltage	Phase	Amps	Eff.	(NPSH)r
	m ³ /h	l/m	gpm	m	ft	r/min	hp	v		%	ft	
CBI 4-30	9	150	40	37	121	3450	1.4	220/460	3	3.9/2.4	28	9.5

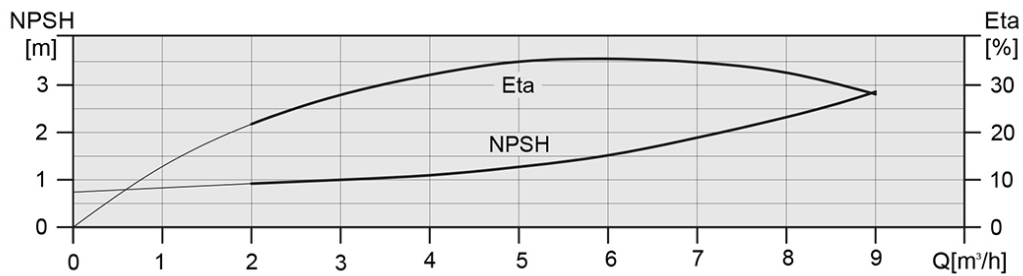
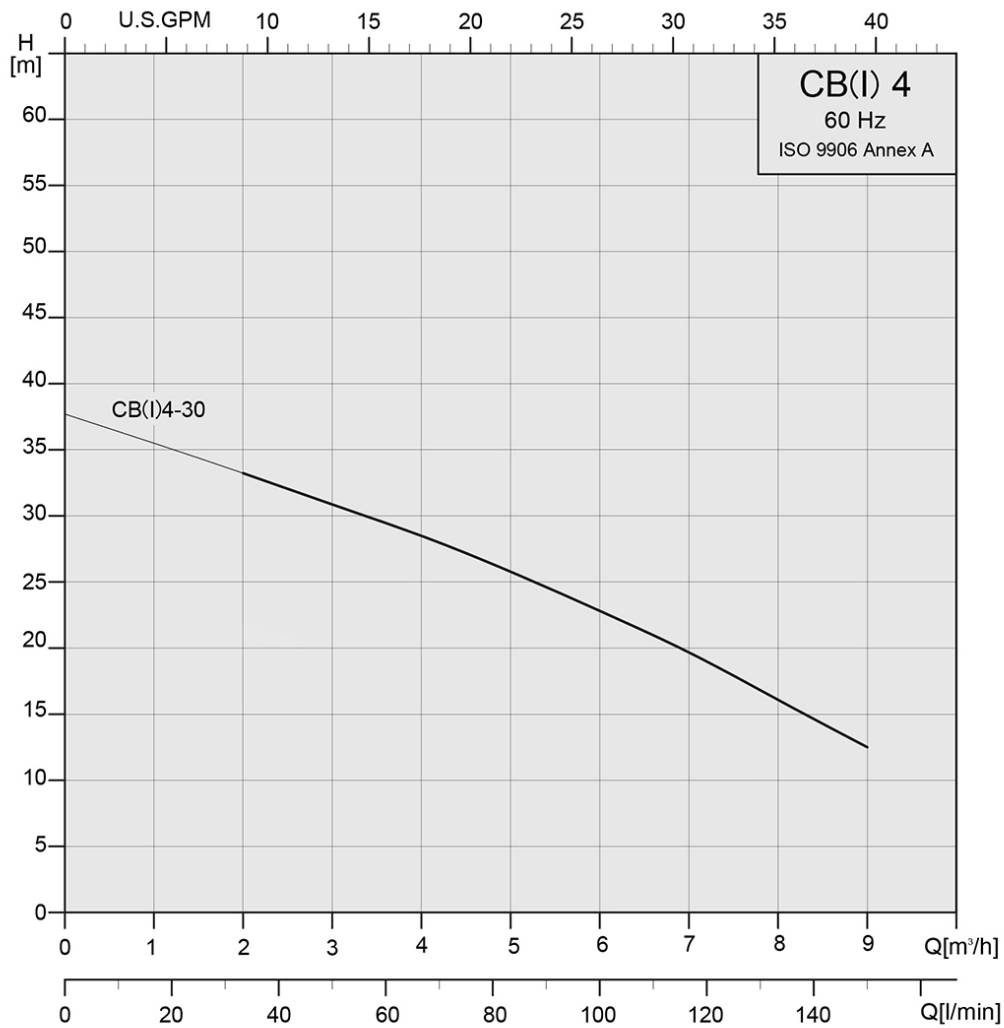

Project	Project ID	Created by	Created on	Last update
---------	------------	------------	------------	-------------